

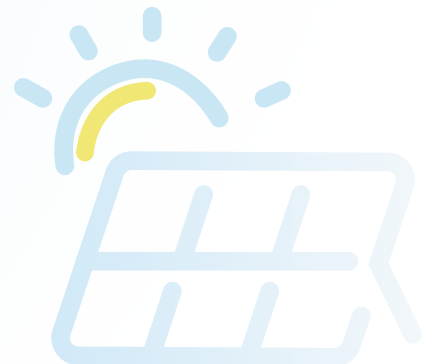

CORPORATION

**T&O CORPORATION, LIGHTING UP THE WAY HOME.
LED STREETS LIGHT**



T&O CORPORATION CO., LTD.

18+

18 industrialization 5.0 factories

20%

Invest 20% of annual income in new product research and development every year

100+

With more than 100+ distributors and partners all over the world

ODM

ODM best service

40+

R&D team more than 40 people

100+

Patent certificate

Provincial high-tech enterprise Provincial gazelle enterprise

Patent certificate

Complete system certificates





PRODUCT DESCRIPTION

• Overview

Super High Performance Price Ratio





Higher efficacy LED by Lumileds, Bridgelux or San'an chip. China famous driver brand SOSEN, INVENTRONICS and ZHIHE. More convenient for installation and maintenance.

Multiple Configurations Optional

10KV SPD is optional.
Glass cover is optional.
Photocell, timer dimming, DALI, 0-10V dimming is optional.
Intelligent control system with 7 PIN NEMA interface is optional.

Wider Application

SHINE GB-21 series LED street light will provide the better lumen output, the better stability and very long lifetime.
Provide 5 years warranty for whole fixture.
It can be applied to streets, roads, highways, squares, parks and parking lots.

LED Source	Photocell
 <p>Provide excellent lumen output, the best stability and excellent visual perception. (Cree, Nichia, Osram & etc. is optional)</p>	 <p>UL/TUV certificated Switch on when illuminance <6 LUX Switch off when illuminance >50LUX 3 Pin/5 Pin/7Pin</p>
LED Driver	Surge Protector Device
	 <p>10KV 5KA high quality Surge Protector Device, can avoid the loss by thunderstrike or surge effectively. (20KV 10KA is optional.)</p>





CORPORATION

• Light Distribution

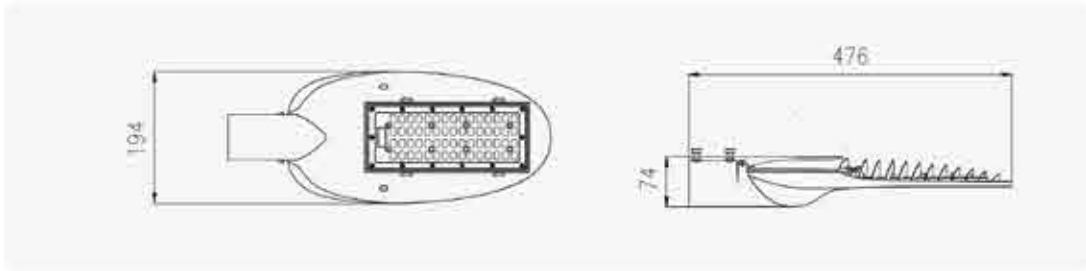

• Product display



• Product parameters

ITEM	GB-2102
Nominal Power	40W-60W
Input Voltage	100-277VAC, 50/60Hz
Power Factor	>0.95
THD	<15%
Light Distribution	I-S, II-M, III-M, V
CCT	2700K-6500K
CRI	Ra>70
SDCM Value	<5SDCM
Protection Grade	IP67, IK09
LED	Lumileds LUXEON
Electrical Protection	CLASS I or CLASS II
Luminous Flux	120-140Lm/W
Housing	Die-casting Aluminum
Warranty	5 Years

: บริษัท ทีแอนด์โอ คอร์ปอเรชั่น จำกัด (T&O CORPORATION CO.,LTD.)
 : (สำนักงานใหญ่) เลขที่ 26/18 หมู่ที่ 5 ตำบลลุดตา อำเภอลำลูกกา จังหวัดปทุมธานี 12130
 : Tel. 081-357-2676, 084-101-1122, 092-685-9955
 Email : Tand02564@gmail.com
 Website : www.tandocorporation.com





PRODUCT DESCRIPTION

• Overview

Super High Performance Price Ratio



Higher efficacy LED by Lumileds, Bridgelux or San'an chip. China famous driver brand SOSEN, INVENTRONICS and ZHIHE. More convenient for installation and maintenance.

Multiple Configurations Optional

10KV SPD is optional.
Glass cover is optional.
Photo cell, timer dimming, DALI, 0-10V dimming is optional.
Intelligent control system with 7 PIN NEMA interface is optional.

Wider Application

SHINE GB-21 series LED street light will provide the better lumen output, the better stability and very long lifetime.
Provide 5 years warranty for whole fixture.
It can be applied to streets, roads, highways, squares, parks and parking lots.

LED Source	Photocell
 <p>Provide excellent lumen output, the best stability and excellent visual perception. (Cree, Nichia, Osram & etc. is optional)</p>	 <p>UL/TUV certificated Switch on when illuminance <6 LUX Switch off when illuminance >50LUX 3 Pin/5 Pin/7Pin</p>
LED Driver	Surge Protector Device
	 <p>10KV 5KA high quality Surge Protector Device, can avoid the loss by thunderstrike or surge effectively. (20KV 10KA is optional.)</p>



• Light Distribution

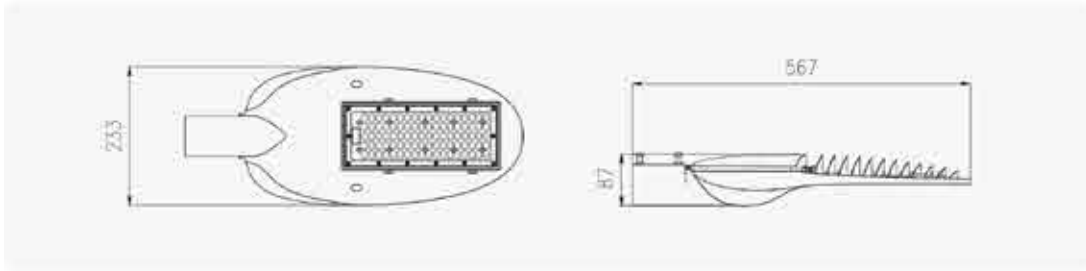

• Product display



• Product parameters

ITEM	GB-2103
Nominal Power	80W-100W
Input Voltage	100-277VAC, 50/60Hz
Power Factor	>0.95
THD	<15%
Light Distribution	I-S, II-M, III-M, V
CCT	2700K-6500K
CRI	Ra>70
SDCM Value	<5SDCM
Protection Grade	IP67, IK09
LED	Lumileds LUXEON
Electrical Protection	CLASS I or CLASS II
Luminous Flux	120-140lm/W
Housing	Die-casting Aluminum
Warranty	5 Years

📍 : บริษัท ทีแอนด์โอ คอร์ปอเรชั่น จำกัด (T&O CORPORATION CO.,LTD.)
 : (สำนักงานใหญ่) เลขที่ 26/18 หมู่ที่ 5 ตำบลลุดด อำเภอลำลูกกา จังหวัดปทุมธานี 12130

☎ : Tel. 081-357-2676, 084-101-1122, 092-685-9955

✉ Email : Tand02564@gmail.com

🌐 Website : www.tandocorporation.com





PRODUCT DESCRIPTION

• Overview

Super High Performance

Price Ratio Higher efficacy LED by Lumileds, Bridgelux or San'an chip. China famous driver brand SOSEN, INVENTRONICS and MOSO. More convenient for installation and maintenance.

Multiple Configurations Optional

10KV SPD is optional.

Photocell, timer dimming, DALI, 0-10V dimming is optional.

Intelligent control system with 7 PIN NEMA interface is optional.

Wider Application

SHINE SH51-G series LED street light will provide the best lumen output, the better stability and very long lifetime.

Provide over 5 years warranty for whole fixture. It can be applied to streets, roads, highways, squares, parks and parking lots.

LED Source	Photocell
 <p>Provide excellent lumen output, the best stability and excellent visual perception. (Cree, Nichia, Osram & etc. is optional)</p>	 <p>UL/TUV certificated Switch on when illuminance <6 LUX Switch off when illuminance >50LUX 3 Pin/5 Pin/7Pin</p>
LED Driver	Surge Protector Device
	 <p>10KV 5KA high quality Surge Protector Device, can avoid the loss by thunderstrike or surge effectively. (20KV 10KA is optional.)</p>



• Product parameters

ITEM	GB-5101-G
Nominal Power	30-60W
Input Voltage	100-277VAC
Power Factor	>0.95
Light Distribution	TYPE II, III
CCT	2700K~6500K
CRI	Ra>70
Protection Grade	IP67, IK09
LED	Lumileds 3030 or 5050
Pole diameter	40-60mm
Luminous	>130Lm/W
Flux Housing	Die-casting Aluminum
Relative humidity	-20°C~50°C
Ambient temperature	10%~95%RH

• Product display



• Size Data

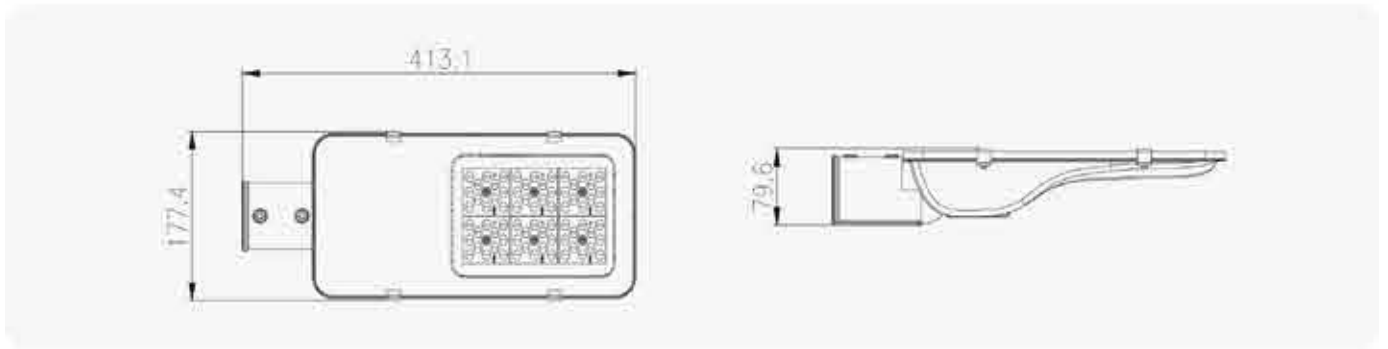

• Light Distribution

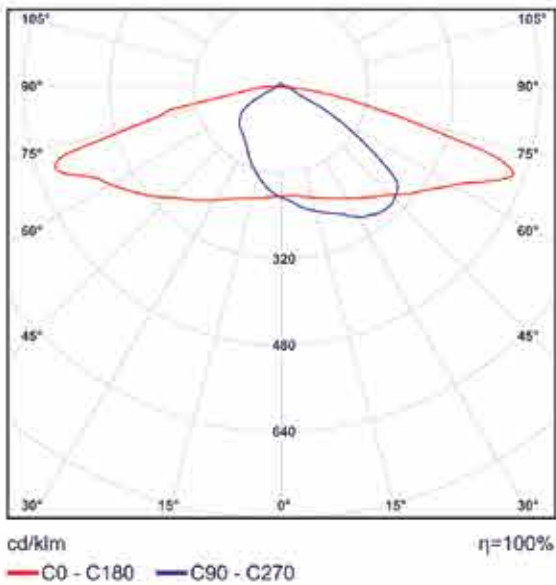

Type II

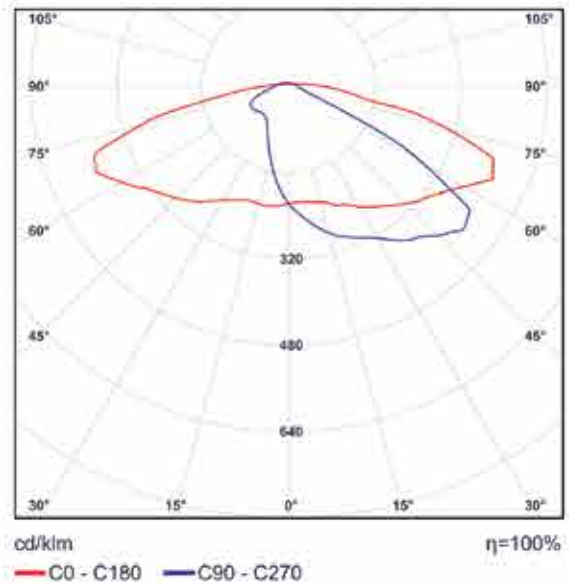

Type III





PRODUCT DESCRIPTION

• Overview

Super High Performance





Price Ratio Higher efficacy LED by Lumileds, Bridgelux or San'an chip. China famous driver brand SOSEN, INVENTRONICS and MOSO. More convenient for installation and maintenance.

Multiple Configurations Optional

10KV SPD is optional.
 Photocell, timer dimming, DALI, 0-10V dimming is optional.
 Intelligent control system with 7 PIN NEMA interface is optional.

Wider Application

SHINE SH51-G series LED street light will provide the best lumen output, the better stability and very long lifetime.
 Provide over 5 years warranty for whole fixture. It can be applied to streets, roads, highways, squares, parks and parking lots.

<p style="text-align: center;">LED Source</p>  <p>Provide excellent lumen output, the best stability and excellent visual perception. (Cree, Nichia, Osram & etc. is optional)</p>	<p style="text-align: center;">Photocell</p>  <p>UL/TUV certified Switch on when illuminance <6 LUX Switch off when illuminance >50LUX 3 Pin/5 Pin/7Pin</p>
<p style="text-align: center;">LED Driver</p> 	<p style="text-align: center;">Surge Protector Device</p>  <p>10KV 5KA high quality Surge Protector Device, can avoid the loss by thunderstrike or surge effectively. (20KV 10KA is optional.)</p>



• Product parameters

ITEM	GB-5102-L
Nominal Power	80-120W
Input Voltage	100-277VAC
Power Factor	>0.95
Light Distribution	TYPE II, III
CCT	2700K~6500K
CRI	Ra>70
Protection Grade	IP67, IK09
LED	Lumileds 3030 or 5050
Pole diameter	40-60mm
Luminous	>130Lm/W
Flux Housing	Die-casting Aluminum
Relative humidity	-20°C~50°C
Ambient temperature	10%~95%RH

• Product display



📍 : บริษัท ทีแอนด์โอ คอร์ปอเรชั่น จำกัด (T&O CORPORATION CO.,LTD.)
 : (สำนักงานใหญ่) เลขที่ 26/18 หมู่ที่ 5 ตำบลตุ้มโฮง อำเภอลำลูกกา จังหวัดปทุมธานี 12130

☎ : Tel. 081-357-2676, 084-101-1122, 092-685-9955

✉ Email : Tand02564@gmail.com

🌐 Website : www.tandocorporation.com



• Size Data

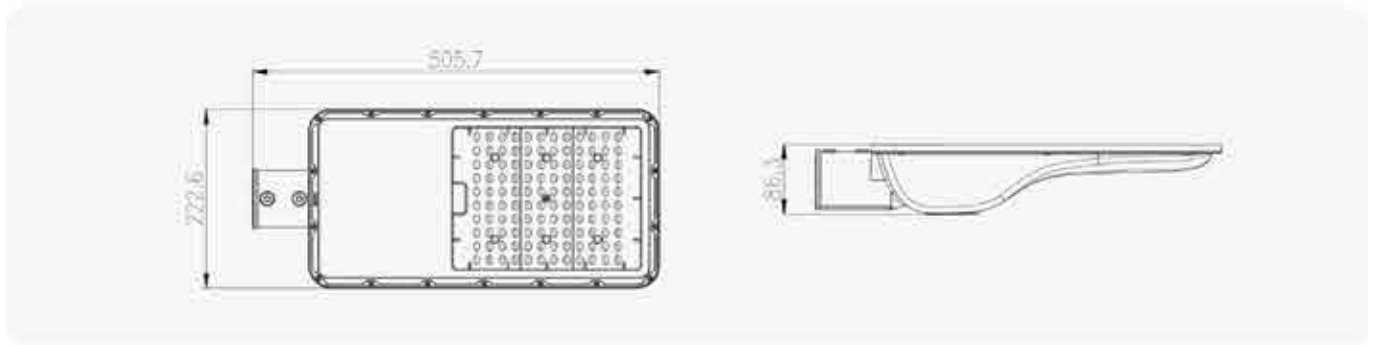

• Light Distribution

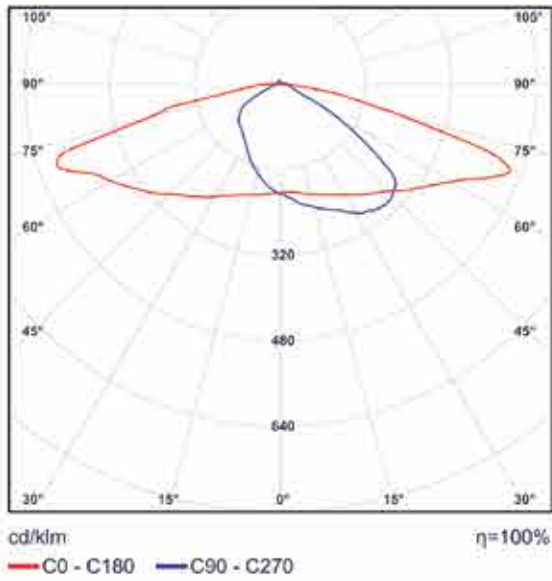

Type II

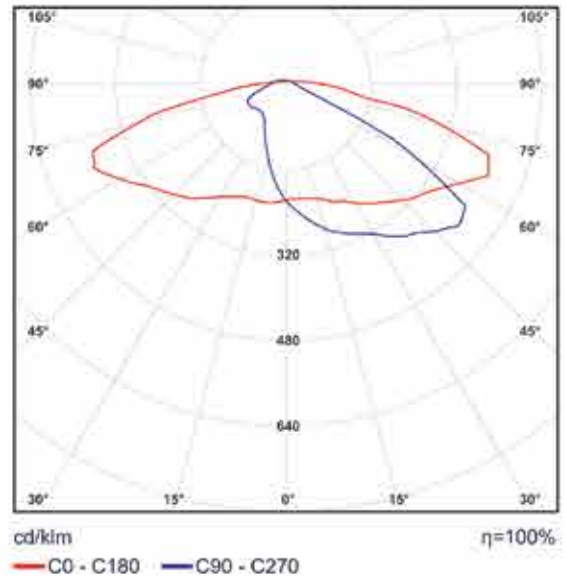

Type III





PRODUCT DESCRIPTION

• Overview

Super High Performance

Price Ratio Higher efficacy LED by Lumileds, Bridgelux or San'an chip. China famous driver brand SOSEN, INVENTRONICS and MOSO. More convenient for installation and maintenance.

Multiple Configurations Optional

10KV SPD is optional.

Photocell, timer dimming, DALI, 0-10V dimming is optional.

Intelligent control system with 7 PIN NEMA interface is optional.

Wider Application

SHINE SH51-G series LED street light will provide the best lumen output, the better stability and very long lifetime.

Provide over 5 years warranty for whole fixture. It can be applied to streets, roads, highways, squares, parks and parking lots.

LED Source	Photocell
 <p>Provide excellent lumen output, the best stability and excellent visual perception. (Cree, Nichia, Osram & etc. is optional)</p>	 <p>UL/TUV certificated Switch on when illuminance <6 LUX Switch off when illuminance >50LUX 3 Pin/5 Pin/7Pin</p>
LED Driver	Surge Protector Device
	 <p>10KV 5KA high quality Surge Protector Device, can avoid the loss by thunderstrike or surge effectively. (20KV 10KA is optional.)</p>





T&O CORPORATION

• Product parameters

ITEM	GB-5103-G
Nominal Power	150-180W
Input Voltage	100-277VAC
Power Factor	>0.95
Light Distribution	TYPE II, III
CCT	2700K-6500K
CRI	Ra>70
Protection Grade	IP67, IK09
LED	Lumileds 3030 or 5050
Pole diameter	40-60mm
Luminous	>130Lm/W
Flux Housing	Die-casting Aluminum
Relative humidity	-20°C~50°C
Ambient temperature	10%~95%RH

• Product display



• Size Data

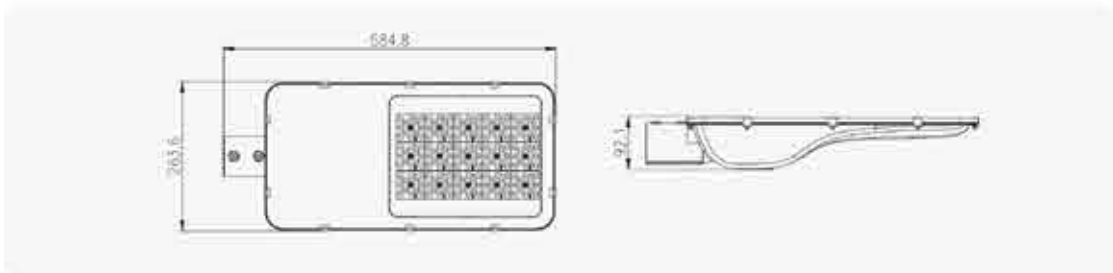

 : บริษัท ทีแอนด์โอ คอร์ปอเรชั่น จำกัด (T&O CORPORATION CO.,LTD.)
 : (สำนักงานใหญ่) เลขที่ 26/18 หมู่ที่ 5 ตำบลคูคต อำเภอลำลูกกา จังหวัดปทุมธานี 12130
 : Tel. 081-357-2676, 084-101-1122, 092-685-9955
 Email : Tand02564@gmail.com
 Website : www.tandocorporation.com



• Light Distribution

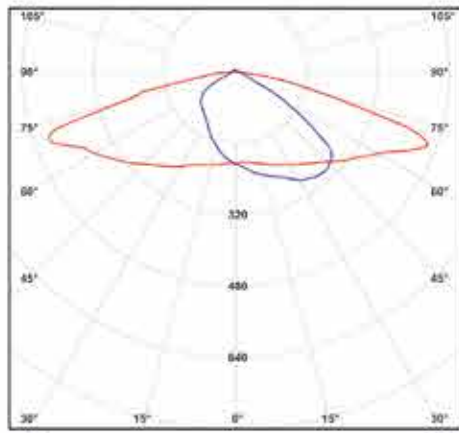

cd/km η=100%
— C0 - C180 — C90 - C270

Type II

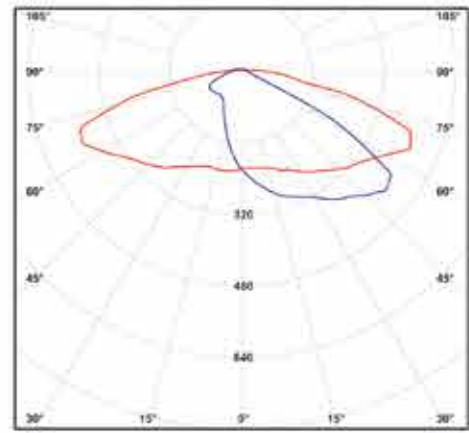

cd/km η=100%
— C0 - C180 — C90 - C270

Type III

• Installation

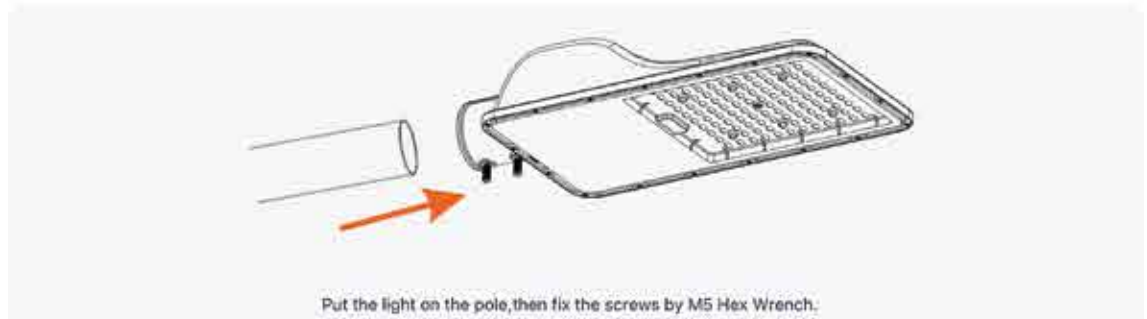

Put the light on the pole, then fix the screws by M5 Hex Wrench.

• Sensor Control System

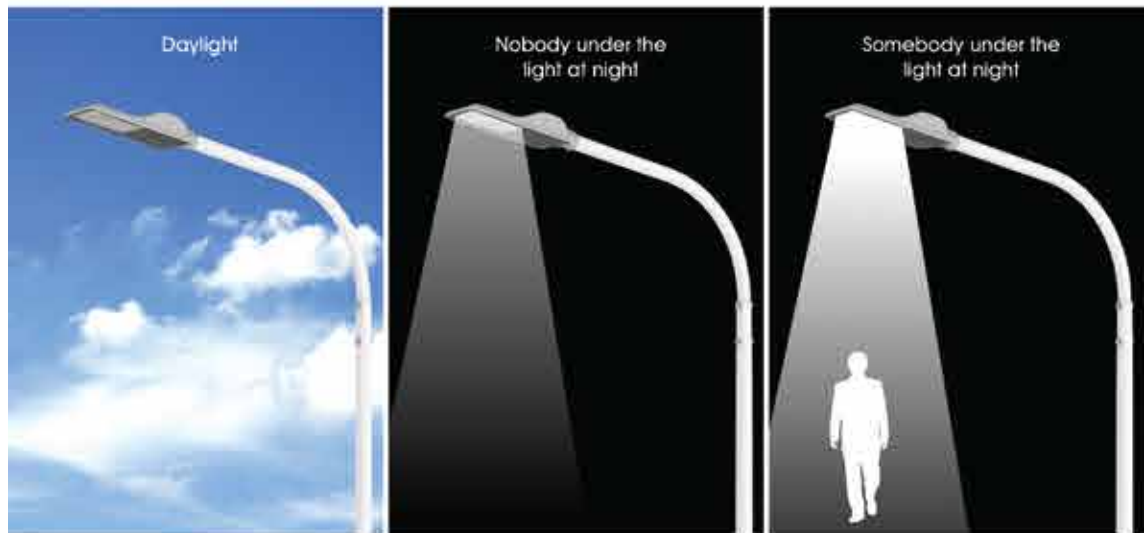

	Induction time	Somebody under the light	Nobody under the light
When the illumination is less than 10lux, it begins to work.	2H	100%	30%
	3H	50%	20%
	6H	20%	10%
	1H	30%	10%

Daylight

Automatic closing





PRODUCT DESCRIPTION

• Overview

Super High Performance Price Ratio

Economical design for project and wholesale:

Higher quality Lumileds 3030/5050 led chips, efficiency is 130~160lm/w;

Tempered glass or Optic Lens are optional; Adjust arm or hoops are optional;

Spirit bubble make the installation easy; SPD, Photocell, Dali, 0/1-10v Dimming is optional,

7P Nema&Zhaga socket for Intelligent control are optional;

Multiple optics lens, -suitable for different condition street;

CE, ROHS, IP, IK, SALT SPRAY certificates.

Wider Application

GB-81 series LED street light will provide the best lumen output,

The better stability and very long lifetime.

Provide 2~5 years warranty for whole fixture.

It can be applied to steets, roads, highways, squares, and parking lots.

Two Installations



📍 : บริษัท ทีแอนด์โอ คอร์ปอเรชั่น จำกัด (T&O CORPORATION CO.,LTD.)
 (สำนักงานใหญ่) เลขที่ 26/18 หมู่ที่ 5 ตำบลคูคต อำเภอลำลูกกา จังหวัดปทุมธานี 12130

☎ : Tel. 081-357-2676, 084-101-1122, 092-685-9955

✉ Email : Tand02564@gmail.com

🌐 Website : www.tandocorporation.com



Lens Cover



Photocell

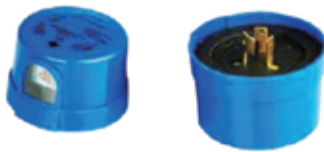

Switch on when illuminance <6 LUX
Switch off when illuminance >50LUX
3 Pin/5 Pin/7Pin

Surge Protector Device



Series connection

Parallel connection

10KV 5KA high quality Surge Protector Dvice, can avoid the loss by thunderstrike or surge effectively.(20KV 10KA is optional.)

• Product display

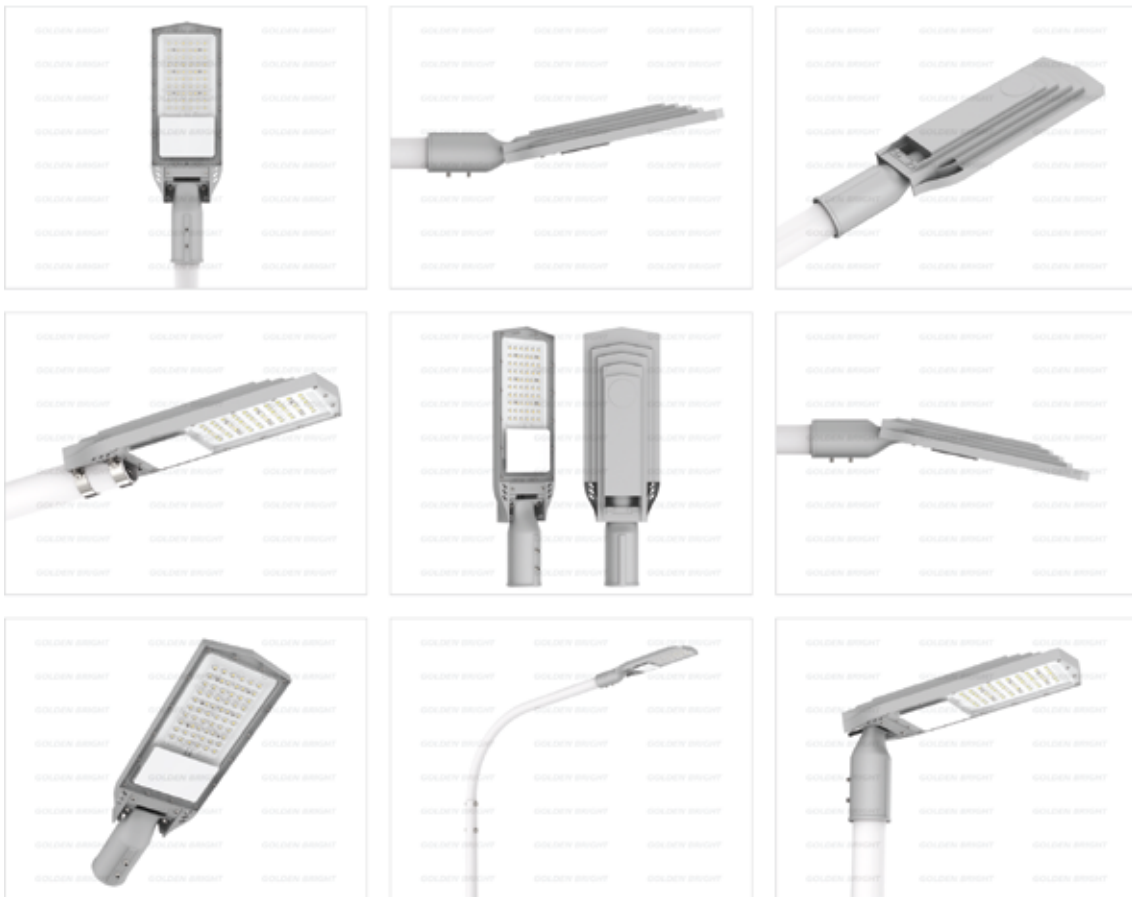

📍 : บริษัท ทีแอนด์โอ คอร์ปอเรชั่น จำกัด (T&O CORPORATION CO.,LTD.)
: (สำนักงานใหญ่) เลขที่ 26/18 หมู่ที่ 5 ตำบลคูคต อำเภอลำลูกกา จังหวัดปทุมธานี 12130

☎ : Tel. 081-357-2676, 084-101-1122, 092-685-9955

✉ Email : Tand02564@gmail.com

🌐 Website : www.tandocorporation.com



• Product parameters

ITEM	GB-8101-L
Nominal Power	30-60W
Input Voltage	100-277VAC
Power Factor	>0.95
Light Distribution	TYPE II, III
CCT	2700K-6500K
CRI	Ra>70
Protection Grade	IP67, IK09
LED	LUMULEDS 3030/5050 LEDS
Pole diameter	40-60mm
Luminous Flux	>130Lm/W(3030) / >160Lm/W(5050)
Housing	Die-casting Aluminum
Relative humidity	-20°C~+50°C
Warranty	≥5years

• Size Data

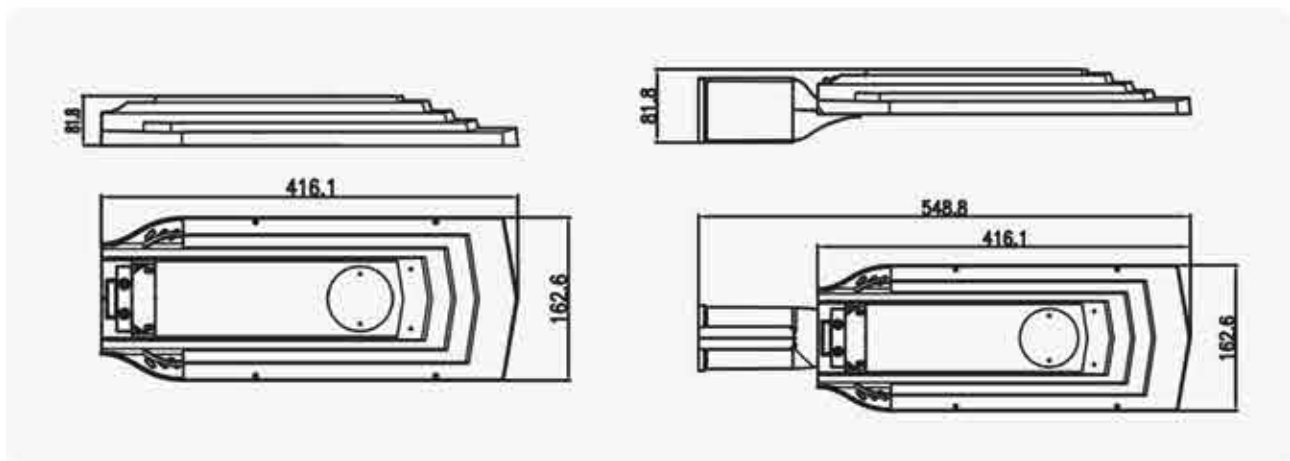



PRODUCT DESCRIPTION

• Overview

Super High Performance Price Ratio

Economical design for project and wholesale;
 Higher quality Lumileds 3030/5050 led chips, efficiency is 130~160lm/w;
 Tempered glass or Optic Lens are optional; Adjust arm or hoops are optional;
 Spirit bubble make the installation easy; SPD, Photocell, Dali, 0/1-10v Dimming is optional,
 7P Nema&Zhaga socket for Intelligent control are optional;
 Multiple optics lens, -suitable for different condition street;
 CE, ROHS, IP, IK, SALT SPRAY certificates.

Wider Application

GB-81 series LED street light will provide the best lumen output,
 The better stability and very long lifetime.
 Provide 2-5 years warranty for whole fixture.
 It can be applied to steets, roads, highways, squares, and parking lots.





CORPORATION

Glass Cover



Photocell



Switch on when illuminance <6 LUX
Switch off when illuminance >50LUX
3 Pin/5 Pin/7Pin

Surge Protector Device



Series connection

Parallel connection

10KV 5KA high quality Surge Protector Dvice, can avoid the loss by thunderstrike or surge effectively.(20KV 10KA is optional.)

• Product display



📍 : บริษัท ทีแอนด์โอ คอร์ปอเรชั่น จำกัด (T&O CORPORATION CO.,LTD.)
: (สำนักงานใหญ่) เลขที่ 26/18 หมู่ที่ 5 ตำบลคูคต อำเภอลำลูกกา จังหวัดปทุมธานี 12130

📞 : Tel. 081-357-2676, 084-101-1122, 092-685-9955

✉ Email : Tand02564@gmail.com

🌐 Website : www.tandocorporation.com



T&O CORPORATION CO., LTD.

• Product parameters

ITEM	GB-8103-G
Nominal Power	120-150W
Input Voltage	100-277VAC
Power Factor	>0.95
Light Distribution	TYPE II, III
CCT	2700K-6500K
CRI	Ra>70
Protection Grade	IP67, IK09
LED	LUMULEDS 3030/5050 LEDS
Pole diameter	40-60mm
Luminous Flux	>130Lm/W(3030) / >160Lm/W(5050)
Housing	Die-casting Aluminum
Relative humidity	-20°C~+50°C
Warranty	≥5years

• Size Data

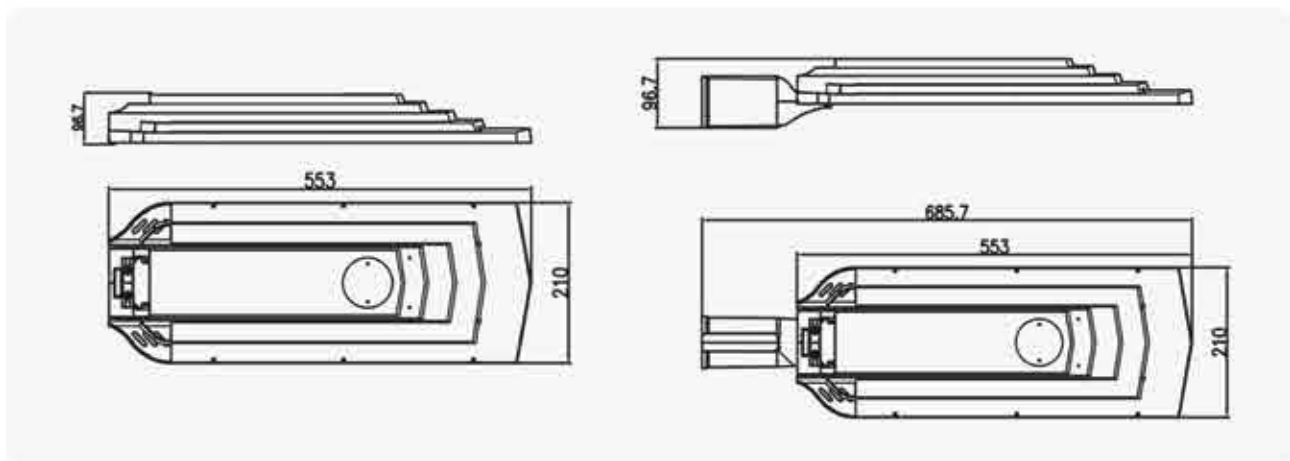

Professional LED Luminaries Manufacturer



泛光灯

DL3003

产品描述

- 8个尺寸的灯壳可选, 可做10-400W
- 灯体材质为ADC12压铸铝
- 装超白钢化玻璃, 模组化配光透镜, 配光角度可选
- 灯具表面磷酸洗, 防紫外纯聚酯塑粉喷涂, 抗腐蚀, 灯具可用于沿海地区
- 安装高性能LED芯片, 光效可达150lm/W
- 防护等级为IP66/IK10

Specification

- We have 8 sizes housings, which support 10-400W
- ADC12 die casting aluminum body
- Super white tempered glass, adopt modular light distribution lens and all types beam angles
- UV-resistance and anti-corrosion coating, it can be used in coastal areas
- Using high quality LED chips, the light efficiency is more than 150lm/W
- Protective grades are IP66/IK10



尺寸简图 Dimensions

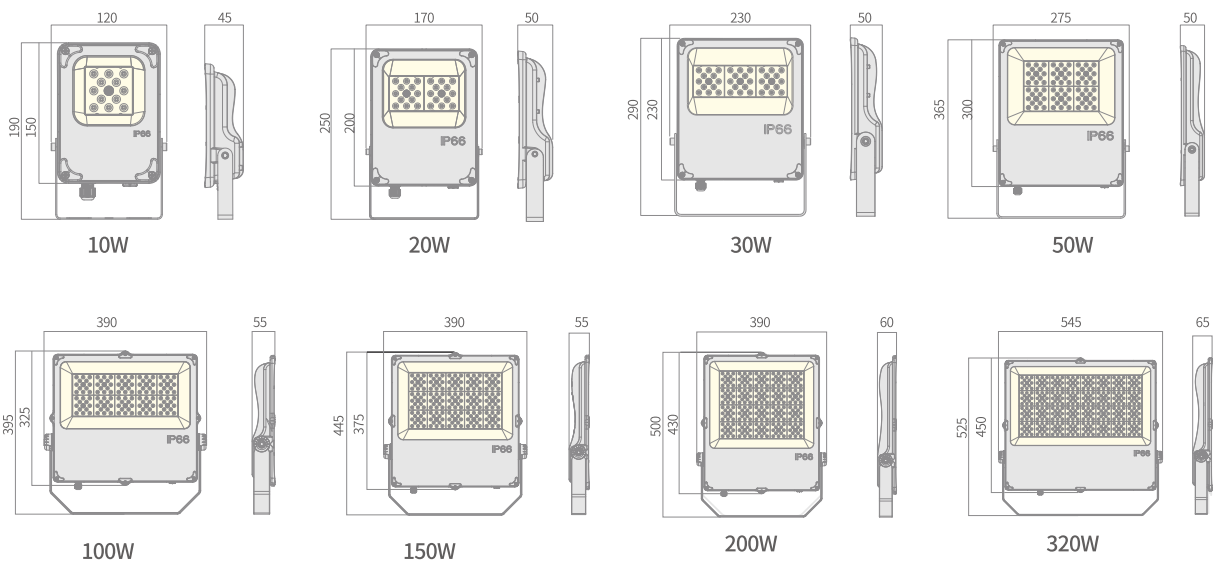



CORPORATION

LED FLOOD LIGHTS

产品应用 Application



应用透镜 Optical Application

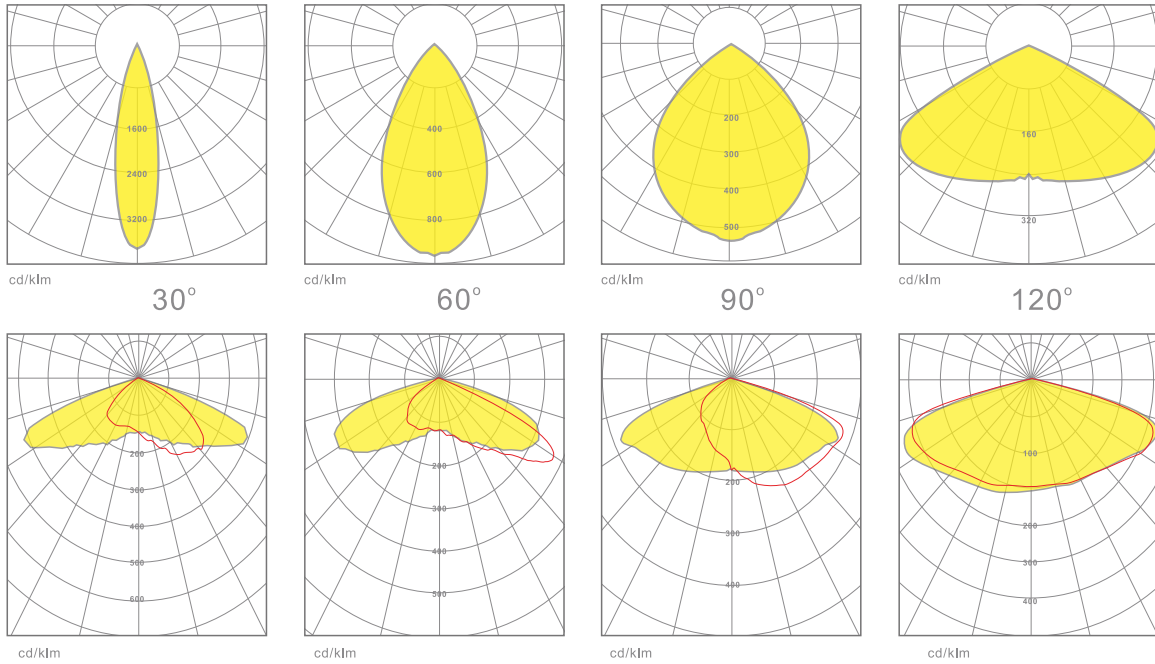

技术参数 Technical Data

Model Number (型号)	DL3003-01-010	DL3003-02-020	DL3003-03-030	DL3003-04-050	DL3003-05-100	DL3003-06-150	DL3003-07-200	DL3003-08-320
Product Dimension 产品尺寸(mm)	190*120*45	250*170*51	290*230*50	365*275*50	395*390*55	445*39*55	500*390*60	5255*545*65
Input Voltage(输入电压)	AC85-305V 50/60Hz							
Power	10W	20W	30W	50W	100W	150W	200W	320W
LED Type	EMC3030							
LED Quantity	12psc	24psc	36psc	72psc	120psc	180psc	240psc	344psc
Light Efficiency	>150lm/W	>150lm/W	>150lm/W	>150lm/W	>150lm/W	>150lm/W	>150lm/W	>150lm/W
Color Temperature	2700-6500K							
CRI	Ra70							

📍 : บริษัท ทีแอนด์โอ คอร์ปอเรชั่น จำกัด (T&O CORPORATION CO.,LTD.)
 : (สำนักงานใหญ่) เลขที่ 26/18 หมู่ที่ 5 ตำบลคูคต อำเภอลำลูกกา จังหวัดปทุมธานี 12130

☎ : Tel. 081-357-2676, 084-101-1122, 092-685-9955

✉ Email : Tand02564@gmail.com

🌐 Website : www.tandocorporation.com



T&O CORPORATION CO., LTD.

R-Series



KEY ADVANTAGES

- Top and bottom vent convection, high-quality heat dissipation
- Wattage from 100W to 240W optional
- Power Selectable (Optional)
- High energy savings compared to systems with traditional discharge lamps
- Light-on-demand feature with optional motion sensor
- Robust design
- Emergency lighting with optional battery
- High visual comfort
- No hazardous materials
- Fast ROI thanks to long life span and reduced maintenance
- Compact housing optimised for heat dissipation and reduced dust accumulation
- Dedicated range of mounting accessories

TYPES OF APPLICATION

- CAR PARKS
- LARGE AREAS
- INDUSTRIAL HALLS & WAREHOUSES
- SPORT FACILITIES



CAR PARKS



LARGE AREAS



INDUSTRIAL HALLS & WAREHOUSES



SPORT FACILITIES



📍 : บริษัท ทีแอนด์โอ คอร์ปอเรชั่น จำกัด (T&O CORPORATION CO.,LTD.)
 (สำนักงานใหญ่) เลขที่ 26/18 หมู่ที่ 5 ตำบลคูคต อำเภอลำลูกกา จังหวัดปทุมธานี 12130

☎ : Tel. 081-357-2676, 084-101-1122, 092-685-9955

✉ Email : Tand02564@gmail.com

🌐 Website : www.tandocorporation.com





CORPORATION

R-SERIES | CHARACTERISTICS

GENERAL INFORMATION

Driver included	Yes
CE mark	Yes
RoHS compliant	Yes
Safety features	Open circuit protection Short circuit protection Overvoltage protection
Testing standard	LM-79-19(all measurements in ISO17025 accredited laboratory)

HOUSING AND FINISH

Housing	Aluminium
Optic	Polycarbonate
Protector	Polycarbonate (with integrated lenses)
Housing finish	Electrostatic polyester powder coating
Standard colour(s)	RAL 9017 black
Tightness level	IP 65
Impact resistance	IK 08

OPERATING CONDITIONS

Operating temperature range (Ta)	-30°C to + 45°C
Operating Humidity	10-90%RH
Mounting Option	Loop Hanging Bracket Mounting
Warranty	5 years

PERFORMANCE

Power	100W/150W/200W/240W
Efficacy	210lm/W,190lm/W,170lm/W,150lm/W
Power Efficiency	≥93%
Start Time	≤0.2S
Warm-up time to 60%	0.5S

ELECTRICAL INFORMATION

Electrical class	Class I EU
Nominal voltage	220-240V 50/60Hz
Power factor (at fullload)	0.9
Surge protection options (kV)	6KV-Line-Line 6KV-Line-Earth
Electromagnetic compatibility (EMC)	EN 55015:2019/A11:2020, EN 61000 3-2:2019, EN 61000-3-3:2013, EN 61547:2009, EN 62493:2015
Control protocol(s)	1-10V, DALI2 (optional)
Emergency	Optional auxiliary battery
Total Harmonic Distortion(THD)	IEC 61000-3-2 Class C <20%
Driver Type	Constant current(CC)

For fixed Class 1 luminaires, overvoltage protective devices which comply with IEC 61643-11 shall be disconnected from the circuit.

withstand voltage	1.5KV 60S 10mA
-------------------	----------------

※Lamp switch must control L line or control L and N lines.

OPTICAL INFORMATION

LED Type	SMD2835
Beam Angle	60° / 90° / 120°
Recommended installation height	4m to 12m
Color Tolerance	Ra70 ≤7 Ra80 ≤5
LED colour temperature	3000K / 4000K / 5000K / 5700K / 6500K
Colour rendering index (CRI)	CRI>70 standard CRI>80 optional
Upward Light Output Ratio (ULOR)	0%

※Ra measurement tolerance is ±2.

LIFETIME OF THE LEDS @ TA 25°C

All configurations	
L70B50	>100,000h
L80B20	>50,000h
L90B10	>30,000h
Switching Cycles	>100,000 times

📍 : บริษัท ทีแอนด์โอ คอร์ปอเรชั่น จำกัด (T&O CORPORATION CO.,LTD.)
: (สำนักงานใหญ่) เลขที่ 26/18 หมู่ที่ 5 ตำบลคูคต อำเภอลำลูกกา จังหวัดปทุมธานี 12130

☎ : Tel. 081-357-2676, 084-101-1122, 092-685-9955

✉ Email : Tand02564@gmail.com

🌐 Website : www.tandocorporation.com



LED High Bay Light |



CORPORATION

R-SERIES | OPTICS AND ACCESSORIES

LIGHT DISTRIBUTIONS

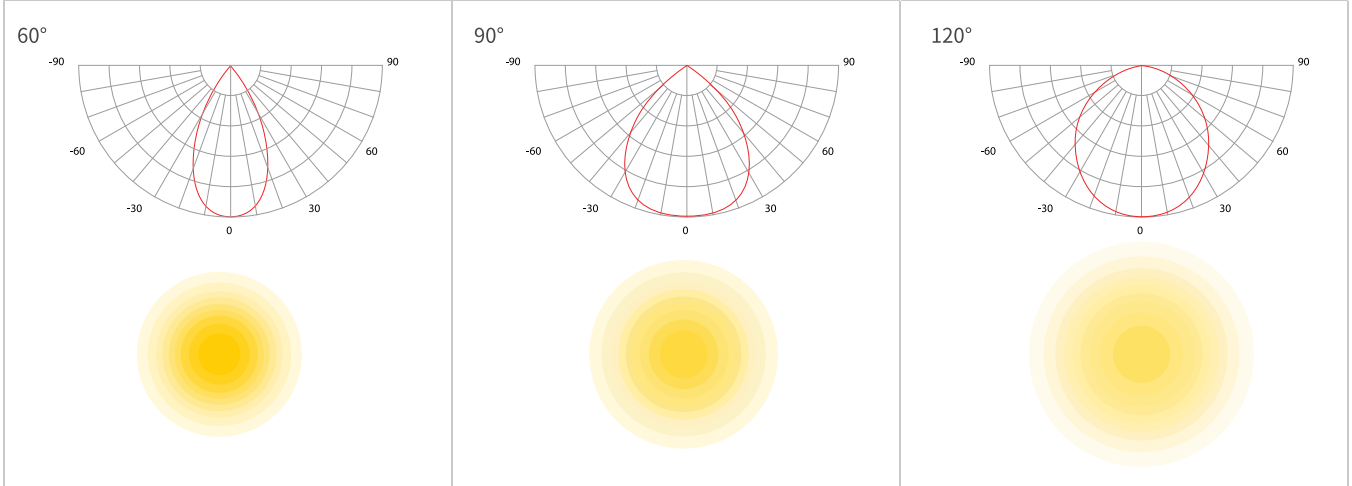

OPTIONAL

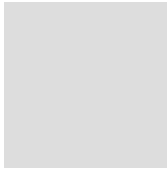

Sosen Led Driver



Philips Led Driver



Lifud Led Driver

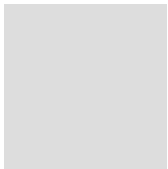

60°/90° PC Lenses



120° PC Lenses



120° Tempered Glass

ACCESSORIES

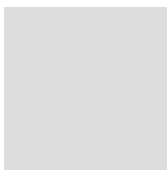

Alum Reflector (Standard)



PC Reflector

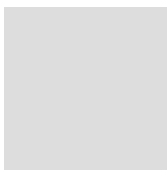

Universal Rotatable Bracket



Safety Chain

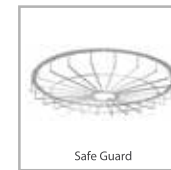

Safe Guard

📍 : บริษัท ทีแอนด์โอ คอร์ปอเรชั่น จำกัด (T&O CORPORATION CO.,LTD.)
: (สำนักงานใหญ่) เลขที่ 26/18 หมู่ที่ 5 ตำบลคูคต อำเภอลำลูกกา จังหวัดปทุมธานี 12130

📞 : Tel. 081-357-2676, 084-101-1122, 092-685-9955

✉ Email : Tand02564@gmail.com

🌐 Website : www.tandocorporation.com



LED High Bay Light |

T&O CORPORATION CO., LTD.



CORPORATION

R-SERIES | DRAWING

⚠ Connecting the cable requires an IP65 Tightness level

100W

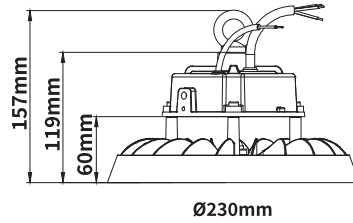

150W

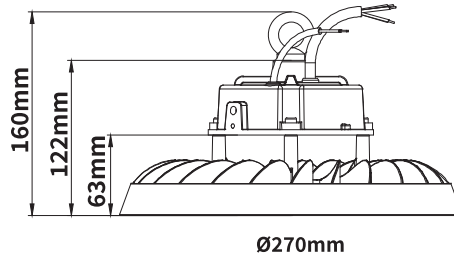

200W

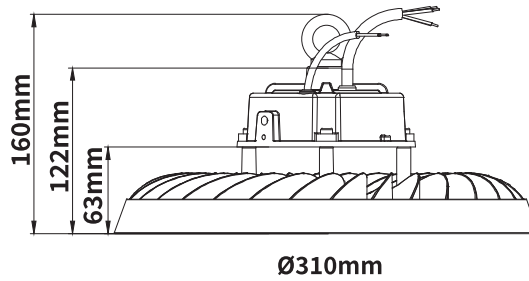

240W

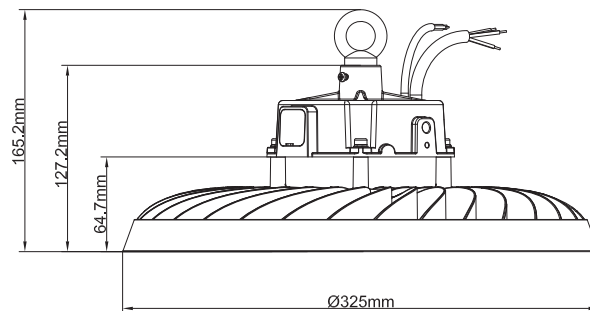

📍 : บริษัท ทีแอนด์โอ คอร์ปอเรชั่น จำกัด (T&O CORPORATION CO.,LTD.)
: (สำนักงานใหญ่) เลขที่ 26/18 หมู่ที่ 5 ตำบลคูคต อำเภอลำลูกกา จังหวัดปทุมธานี 12130
📞 : Tel. 081-357-2676, 084-101-1122, 092-685-9955
✉ Email : Tand02564@gmail.com
🌐 Website : www.tandocorporation.com



LED High Bay Light |

T&O CORPORATION CO., LTD.

• Sensor Control System



	Induction time	Somebody under the light	Nobody under the light
When the illumination is less than 10lux, it begins to work.	2H	100%	30%
	3H	50%	20%
	6H	20%	10%
	1H	30%	10%
Daylight	Automatic closing		





T&O CORPORATION, LIGHTING UP THE WAY HOME.



: บริษัท ทีแอนด์โอ คอร์ปอเรชั่น จำกัด (T&O CORPORATION CO.,LTD.)

: (สำนักงานใหญ่) เลขที่ 26/18 หมู่ที่ 5 ตำบลคูคต อำเภอลำลูกกา จังหวัดปทุมธานี 12130



: Tel. 081-357-2676, 084-101-1122, 092-685-9955



Email : Tand02564@gmail.com



Website : www.tandocorporation.com



CORPORATION

T&O CORPORATION, LIGHTING UP THE WAY HOME.